



Warsaw

ALARM MODULE

USER MANUAL

edition 5W1W2

MD-2 MD-2.A... MD-4 MD-4.A...

[W1], [W2] series

Read the USER MANUAL in its entirety BEFORE installation. Proceed with the installation once you have fully understood this Manual.



To ensure safety during installation and operation of the module, comply with the recommendations and warnings in this User Manual bearing this symbol.



Keep this Manual for reference by the User of the two-threshold gas detection system.

1.	Intended use and matching table	p. 2
2.	Technical parameters	3
3.	Description and method of connecting MD in the system	4
4.	MD installation	8
	PROBLEMS? Useful information	11
5.	Maintenance/operation	12
6.	Warranty terms and conditions	14

PRODUCER: **GAZEX**
gazex Baletowa 16, PL 02-867 Warsaw, POLAND
 Tel: +48 22 644 2511 gazex@gazex.pl
 www.gazex.com

©gazex '2024. All rights reserved. Reproduction or copying, in whole or in part, without the permission of GAZEX is prohibited. The 'GAZEX' logo and the 'gazex' name, as well as 'dex', 'Aktywny System Bezpieczeństwa Instalacji Gazowej' [Active Gas Installation Safety System], ASBIG, are registered trademarks of GAZEX company.

Work and Live Safer with Us! ©gazex

1. INTENDED USE

The **MD-2, MD-2.A, MD-2.A24, MD-4, MD-4.A, MD-4.A24** alarm modules are intended **EXCLUSIVELY** for controlling and powering two-threshold gas detectors of the **DEX®/F, DG/F, and DG.EN** types, manufactured by GAZEX, for use in a Two-Threshold Gas Detection System.

In the following sections of this Manual, each of the said modules will be referred to as the '**MD**' or simply the 'module,' unless the description pertains to a specific model.

In the following sections of this Manual, the term 'detector' or 'DEX' will refer to DEX/F, DG/F, DG.EN detectors for all gas types, unless the description pertains to a specific model.

The module can control the operation of one or two detectors (MD-2, MD-2.A, MD-2.A24) or up to four detectors (MD-4, MD-4.A, MD-4.A24) of the two-threshold type DEX/F, DG/F or DG.EN (different types of detectors can be used simultaneously).

Features and functions of the MD:

- ◆ Powers individual detectors with 9 V (with load monitoring) – can work with two-threshold detectors (with a 4-wire interface) of the DEX/F, DG/F, DG.EN types;
- ◆ Monitors the wired connection status with the detectors (signals a break in any core);
- ◆ Visually signals and records the alarm statuses of each detector as well as the status of the control outputs;
- ◆ Allows manual triggering of output control signals (without the need for detectors to generate alarm signals);
- ◆ Provides constant 12VDC power to additional devices (MDX terminal);
- ◆ Through a (galvanically isolated) alarm input, enables cooperation with additional modules (in a cascading configuration);
- ◆ 12 V alarm outputs control additional sound and visual indicators;
- ◆ Contact outputs (galvanically isolated from the system) control fans, motors, contactors, and information boards;
- ◆ The FAILURE (AWARIA) contact output (galvanically isolated from the system) indicates a fault state in the module;
- ◆ When detectors with smart sensors (indicated by the letter 'N' in the detector model symbol) are connected, signals exceed the recommended calibration period (while maintaining full detector functionality) or permanent sensor damage;
- ◆ All power, input, and output connectors are removable, allowing the use of single- or multi-stranded cables (rope type, without crimping ferrules).

BLOCK DIAGRAM OF A SYSTEM with MD

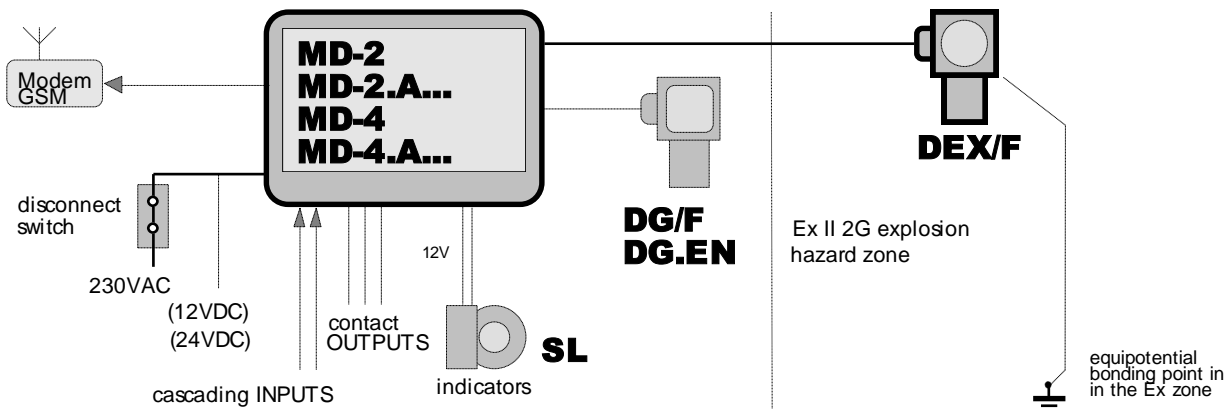

MD MATCHING TABLE

TYPE	MD-2	MD-2.A	MD-2.A24	MD-4	MD-4.A	MD-4.A24
max NUMBER of detectors	2	2	2	4	4	4
NO/NC contact OUTPUTS	2	2	2	2	2	2
FAILURE contact OUTPUT	1	1	1	1	1	1
12V alarm OUTPUTS	2	2	2	2	2	2
Isolated 12V alarm INTPUTS	2	2	2	2	2	2
High-current 12 V OUTPUT controlling the shut-off valve	-	-	-	-	-	-
Supply VOLTAGE	230 VAC	12 VDC	24 VDC	230 VAC	12 VDC	24 VDC

2. TECHNICAL PARAMETERS

Supply voltage	MD-2, MD-4: 230VAC (permissible range +10/-14%) MD-2.A, MD-4.A: 12VDC (acceptable range: 10.5V to 13.8V) MD-2.A24, MD-4.A24: 24VDC (acceptable: 16 to 30V)
Power consumption	<i>max</i> 18W; (MD...A: <i>max</i> 16W); (MD...A24: <i>max</i> 20W)
Operating temperature	+5°C to +35°C recommended optimal, -10°C to +40°C recommended continuous, -15°C to +45°C recommended periodically (<2h/24h)
Number of measurement channels (max number of detectors)	2 , two-threshold detectors (MD-2...) 4 , two-threshold detectors (MD-4...)
Alarm levels	two : warning – ALARM1 (A1) & alarm – ALARM2 (A2)
Alarm memory	for each channel and each level – visual, collective sound; memory of output signals for each level – visual (can be disabled with functional switch W2 'BEZ PAM.' [NO MEMORY])
Memory reset	via a button on the front panel (accessible after opening the cover)
Signal lock	Input: approx. 1 minute after power on; Output: approx. 20s (delay), possibility of permanent lock (service mode) – functional switch W2 'SERWIS' [SERVICE]
Visual signalling (for each detector and output)	A1 – red LED light – exceeded 1 st gas concentration threshold; A2 – red LED light – exceeded 2 nd gas concentration threshold; exceeded recommended calibration period of the detector (<i>with smart sensor: indicated by the letter 'N' in the model symbol</i>) – A2 flashing light only for Input Status of the specified detector
Sound signalling	Internal piezoelectric siren (intermittent tone = module requires servicing), volume approx. 60dB/1m; can be disabled (with functional switch W2 'CISZA' [SILENCE])
Detector power supply	9 V= protected from short-circuit and overcurrent at 200 mA
Fault signalling	For the module: yellow LED AWARIA SYSTEMU (system failure) light; For the detector (only with smart sensor): flashing ALARM1 and ALARM2 lights for Input Status (cannot be reset with the button)
Detector power-on signalling	Green LED light (separate for each detector), overload indication
Quick triggering of output signals	Manual, using 'TEST' button under the terminal strip cover, simultaneously for both thresholds
Module power control	Green LED light, also indicates warm-up
Contact outputs	A1, A2 – normally open and normally closed (NO/NC), potential-free; load capacity: max 4 A (with resistive load) or max 2 A (with inductive load – motors) or max 0.6 A (with purely inductive load – fluorescent lamps); max 250 VAC or 24 VDC; AWARIA (FAILURE) – normally open and normally closed (NO/NC), potential-free; load capacity: max 4 A (with resistive load) or max 2 A (with inductive load); max 30 VAC or 24 VDC; for the above – minimum recommended contact load: ≥10 mA, ≥10 V, ≥1W
Voltage outputs	<ul style="list-style-type: none"> ■ Alarm, 12VDC, un stabilised, for A1 and A2 states, total load ≤ 0.2A, for connecting SL-32(21), S-3x, LD-2 indicators ■ Continuous 12VDC, un stabilised, for powering the MDX module or other devices, max load 0.2A
Alarm inputs	Voltage 12VDC (5 to 16V, max 20mA) for A1, A2; instantaneous, galvanically isolated from other MD circuits; for cascading module connection or other devices
Electrical terminals	Removable, screwless, allow the use of single- or multi-stranded cables (rope type, without crimping ferrules)
Overload protection	Fuse in the primary circuit for 230 VAC or 12/24 VDC power supply; self-resetting fuses with short-circuit current limitation for ALARM.12V outputs; electronic fuses with current limitation for each detector
Dimensions and weight	215 x 240 x 115 mm (H x W x D in installation position); approx. 1.5kg
Enclosure	ABS, 6 cable gland entries, IP54, 3-point mounting

REQUIRED INSTALLATION AREA

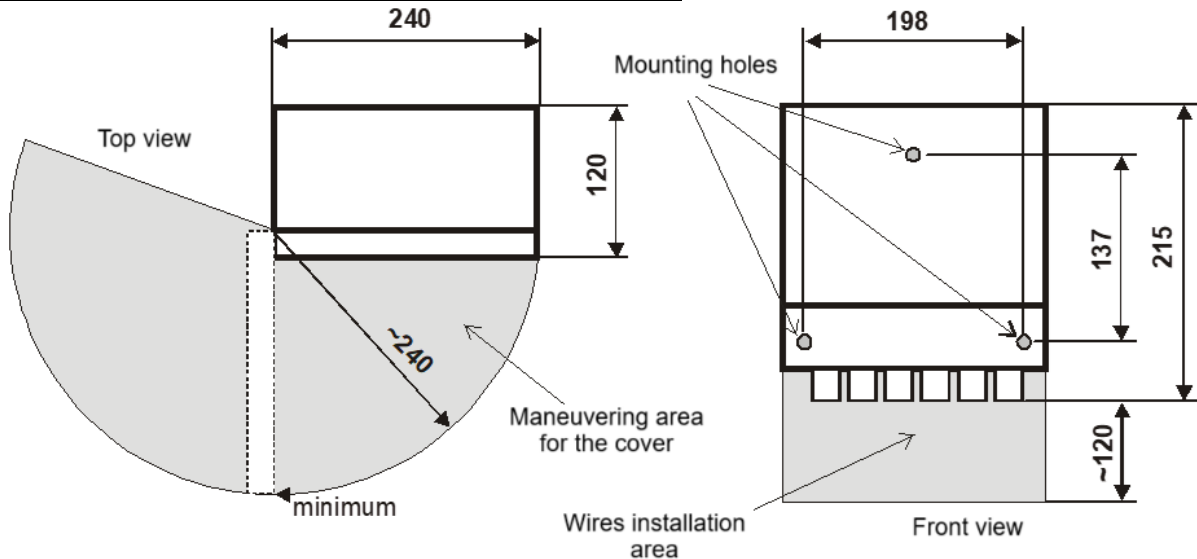

Fig. 3. Dimensions are given in [mm]. The drilling template for the MD mounting holes is printed on the cardboard packaging.

3. DESCRIPTION AND METHOD OF CONNECTING



Photo 3.1 View of the MD front panel (installation position)

- Input status indicator lights (individual detection channels)
- Output status lights
- Alarm memory reset button
- Series name (on the nameplate)
- Terminal chamber cover
- Main fuse (access only for Authorized Service Centre)

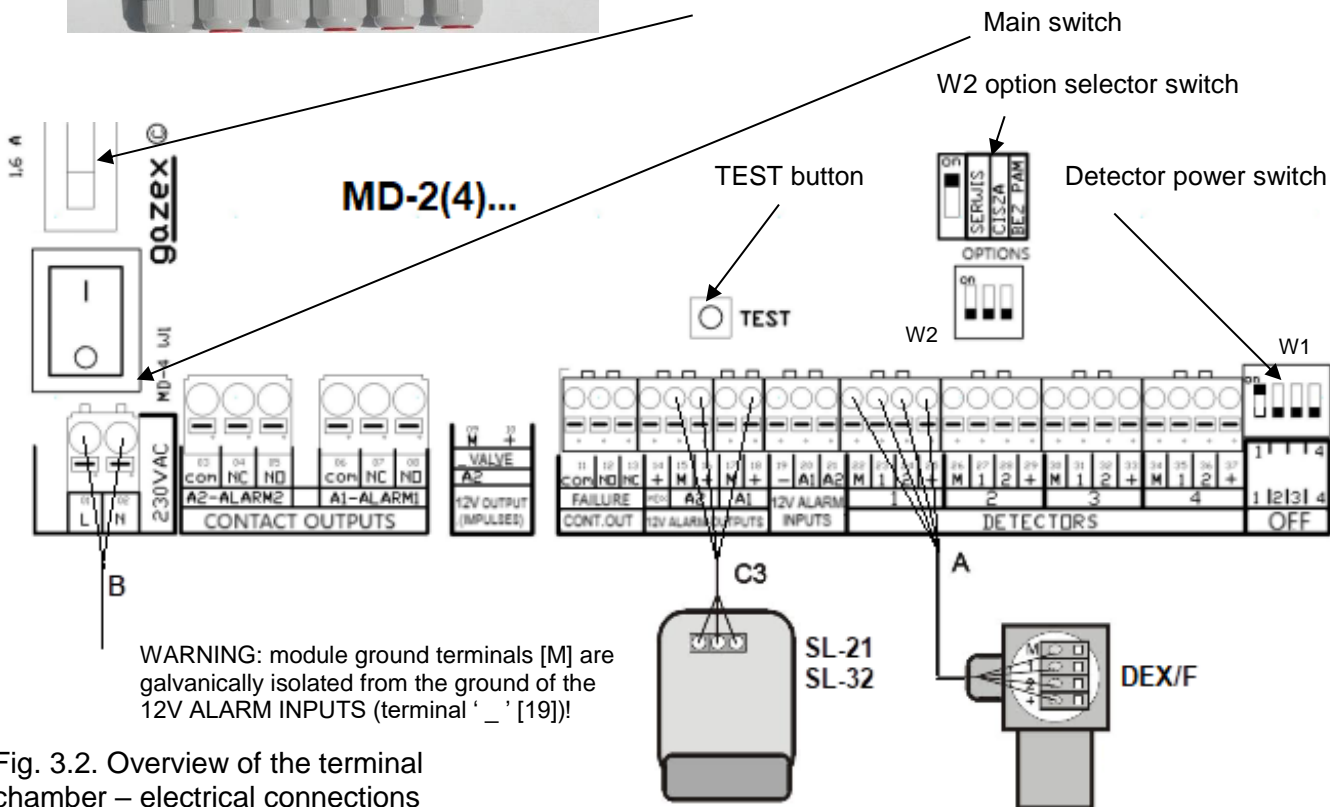

Fig. 3.2. Overview of the terminal chamber – electrical connections

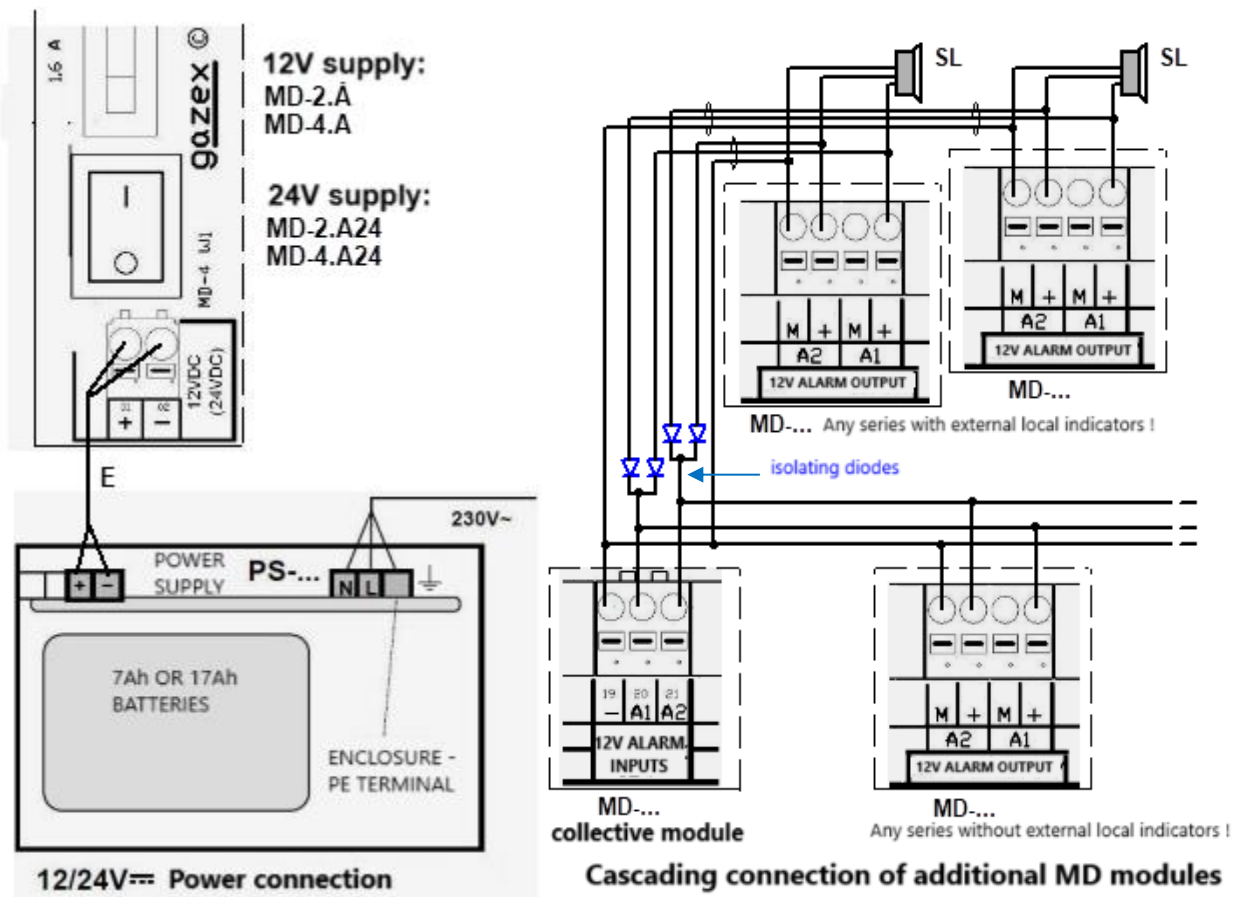

Fig. 3.2.A Wired connections of different system options

Table 3.1. Functions of outputs:

MODULE STATUS [terminal No]	CONTACT OUTPUTS						ALARM.12V OUTPUTS	
	COM-NO pair [11] [12]	COM-NC pair [11] [13]	COM-NO pair [06] [08]	COM-NC pair [06] [07]	COM-NO pair [03] [05]	COM-NC pair [03] [04]	A1 [17] [18]	A2 [15] [16]
NORMAL(0)	OPEN	CLOSED	OPEN	CLOSED	OPEN	CLOSED	no voltage	no voltage
NORMAL(1)	OPEN	CLOSED	OPEN	CLOSED	OPEN	CLOSED	no voltage	no voltage
A1	OPEN	CLOSED	CLOSED	OPEN	OPEN	CLOSED	12 VDC	no voltage
A2	OPEN	CLOSED	CLOSED	OPEN	CLOSED	OPEN	12 VDC	12 VDC
MD power FAILURE (AWARIA)	CLOSED	OPEN	OPEN	CLOSED	OPEN	CLOSED	no voltage	no voltage
DEX power FAILURE (AWARIA)	CLOSED	OPEN	CLOSED	OPEN	CLOSED	OPEN	12 VDC	12 VDC
DEX sensor FAILURE (AWARIA)	OPEN	CLOSED	X	X	X	X	X	X
SERVICE	OPEN	CLOSED	OPEN	CLOSED	OPEN	CLOSED	no voltage	no voltage

Description of MD statuses (with the W2 function switch in a standard position):

NORMAL(0) – The concentration of gases in all connected detectors is below the A1 and A2 thresholds; only the green lights are on: [ZASILANIE] (power) of the connected detectors and [ZASILANIE MODUŁU] (module power).

NORMAL(1) (only for detectors equipped with a smart sensor) – The concentration of gases in all connected detectors is below the A1 and A2 thresholds;
 at least one detector (with a smart sensor) indicates that the recommended calibration period has been exceeded, full functionality of the detector (indicators of other statuses as described below);
 at least one flashing light [ALARM2] Input Status (detector with exceeded recommended calibration period);
 green lights on: [ZASILANIE] (power) of connected detectors and [ZASILANIE MODUŁU] (module power).

A1 – (ALARM 1) At least one detector indicates that the A1 concentration threshold has been exceeded, but **none** indicate an A2 threshold breach; the internal siren's pulsing tone is on;
 [ALARM1] lights are on – at least one Input Status light and [ALARM1] Output Status light, or only [ALARM1] Output Status light (external alarm);
 green [ZASILANIE MODUŁU] (module power) and [ZASILANIE] (power) lights of the connected detectors are on.

A2 – (ALARM 2) At least one detector indicates that the A2 concentration threshold has been exceeded; the internal siren's pulsing tone is on;
 red [ALARM1] and [ALARM2] lights of Input Status for at least one detector are on, and [ALARM1] and [ALARM2] lights of Output Status are on, or only [ALARM1] and [ALARM2] lights of Output Status are on (external alarm);
 green lights [ZASILANIE MODUŁU] (module power) and [ZASILANIE] (power) of the connected detectors are on.

MD POWER FAILURE (AWARIA) – No power or main fuse damage – all lights are off.

DEX POWER FAILURE(AWARIA) – At least one detector has a flashing [ZASILANIE] (power) light and the [ALARM1] and [ALARM2] Input Status lights are on, the [ALARM1] and [ALARM2] Output Status lights are on (with delay);
 the [ZASILANIE MODUŁU] (module power) light is on, and [ZASILANIE] (power) lights for the other connected (operational) detectors are on; the yellow [AWARIA SYSTEMU] (system failure) light is on.

DEX SENSOR FAILURE (AWARIA) (only for detectors with a smart sensor) – Sensor malfunction – only the [ALARM1] and [ALARM2] Input Status lights of the damaged detector are flashing (no response at the module outputs);
 the other lights correspond to the status of the other detectors.

SERVICE – W2 switch in 'SERWIS' [SERVICE] position ON – all outputs are disabled (as in Normal(0)), regardless of input status;
 the yellow [AWARIA SYSTEMU] (system failure) light is on, the internal siren's pulsing tone is on, and other lights correspond to the input status.







Other combinations of output states are treated as failures.

Table 3.2. Functions performed by function switches on the mainboard

Switch	Symbol	Operation description	OFF position (lower)	ON position (upper)
W1	1	Power control for Detector No 1	Detector No 1 detection channel disabled	Detector No 1 power enabled (#)
W1	2	Power control for Detector No 2	Detector No 2 detection channel disabled (#)	Detector No 2 power enabled
W1 (only MD-4...)	3	Power control for Detector No 3	Detector No 3 detection channel disabled (#)	Detector No 3 power enabled
W1 (only MD-4...)	4	Power control for Detector No 4	Detector No 4 detection channel disabled (#)	Detector No 4 power enabled
W2	SERWIS	Disabling contact alarm outputs and 12V alarm outputs	Outputs active, normal operation (#)	Outputs blocked
W2	CISZA	Control of the internal siren	Siren active, normal operation (#)	Siren disabled
W2	BEZ PAM.	Visual and sound memory of alarm statuses on inputs and outputs	Memory active (#)	Memory disabled

(#) – Standard position in a factory-new MD

Table 3.3. Visual Signal Indication of the Module

STATUS/ MD status	Status DESCRIPTION	Light	Light	OUTPUT STATUS lights		INPUT STATUS lights (Detector <i>n</i>)		
		 yellow	 green	 red	 red	 green	 red	 red
		AWARIA SYSTEMU	ZASILANIE MODUŁU	ALARM 1	ALARM 2	ZASILANIE	ALARM 1	ALARM 2
Normal	MD powered on, no detectors enabled	0	1	0	0	0	0	0
Normal/warm-up	Preliminary stabilisation period for detector operation	0	1/0	0	0	x	0	0
NORMAL(0)	System operation	0	1	0	0	1	0	0
NORMAL(1)	System operation, calibration period for detector with smart sensor exceeded (remains functional)	0	1	0	0	1	0	1/0
Normal/A1	Preliminary phase of Detector <i>n</i> with A1 threshold exceeded	0	1	0	0	1	1	0
Normal/A1 mem. on input (*)	Temporary exceeding of A1 threshold for Detector <i>n</i> (e.g., detector test)	0	1	0	0	1	1/0	0
Normal/A2	Preliminary phase of Detector <i>n</i> with A2 threshold exceeded	0	1	0	0	1	1	1
Normal/A2 mem. on input (*)	Temporary exceeding of A2 threshold for Detector <i>n</i> (e.g., detector test)	0	1	0	0	1	1/0	1/0
ALARM 1	A1 alarm for Detector <i>n</i>	0	1	1	0	1	1	0
Normal/A1 mem. on output (*)	A1 status for Detector <i>n</i> recorded on outputs	0	1	1/0	0	1	1/0	0
ALARM 1	Ongoing external A1 alarm	0	1	1	0	x	x	x
Normal/external A1 mem. (*)	External A1 alarm recorded	0	1	1/0	0	x	x	x
ALARM 2	Ongoing A2 alarm for Detector <i>n</i>	0	1	1	1	1	1	1
Normal/A2 mem. on output (*)	A2 status for Detector <i>n</i> recorded on outputs	0	1	1/0	1/0	1	1/0	1/0
ALARM 2	external A2 alarm**	0	1	0	1	x	x	x
Normal/external A2 mem. (*)	External A2 alarm recorded**	0	1	0	1/0	x	x	x
MD Power Failure	No MD power supply	0	0	0	0	0	0	0
DEX Power Failure	Incorrect power supply to Detector <i>n</i>	1	1	x	x	1/0	1	1
DEX Sensor Failure	Only for Detector <i>n</i> with smart sensor	0	1	x	x	1	1/0	1/0
SERVICE	Outputs disabled (W2 'SERWIS' [SERVICE] in ON position)	1	1	x	x	x	x	x

(*) – When configuration switch W2 'BEZ.PAM.' [NO MEMORY] is in OFF position (in ON position = same as Normal)

(**) – 12V alarm inputs labelled A1 and A2 are independent of each other

Light status explained:

0 = off,

1 = on,

1/0 = flashing slowly,

x = any (resulting from system configuration or previous statuses).

4. MD INSTALLATION



The MD installation should be carried out by a competent person.

Installation can begin after allowing sufficient time for the temperatures of the MD and the surrounding air to equalise. Particularly in winter, when there are sub-zero temperatures during transport or storage, it is advisable to wait approx. 20 minutes before removing the MD from its plastic packaging to prevent vapour condensation on the internal circuits of the device.

4.1. Secure the module in the designated location, inaccessible to unauthorised persons, outside of any explosion-hazard zones, and free from strong electromagnetic interference, vibrations, or shocks.

4.1.1. Unscrew the cover of the terminal chamber to reveal two mounting holes.

4.1.2. Hang the module on a previously prepared single hook (in the centre of the designated installation location); mark the positions of the other two mounting holes (installation position according to fig. 3). A drilling template can be found on the module's cardboard packaging.

4.1.3. Insert the wall plugs; screw the module in place. The module must be firmly and securely mounted without any looseness.

4.2. Use the glands to introduce the (round cross-section) connection cables 'A' from the detectors.

The cross-section of cable A core should be selected based on the connection length (L):

L	L < 150 m	L < 300 m
'A'	0.75 mm ² (DEX/F); ≥0.5 mm ² (DG...)	1 mm ²

4.2.1 Ensure the correct order of the detector connection cables – incorrect wiring will cause an alarm status in the module or improper system operation.

4.2.2.A. The module comes with factory-installed connection terminals on all inputs/outputs. The terminal blocks can be removed from the connection pins to facilitate wiring or disassembly. Before removing the terminal blocks, it is recommended to mark all the blocks (e.g., by numbering them), which greatly simplifies reassembly and protects against wiring errors. Single- or multi-stranded wires (rope, without ferrules) can be used. The mechanical properties of the power connection terminals and alarm contact outputs (A1, A2) allow for the installation of conductors with cross-sections of 0.2 to 2.5mm², while other terminals can accommodate conductors with cross-sections of 0.2 to 1.5mm².

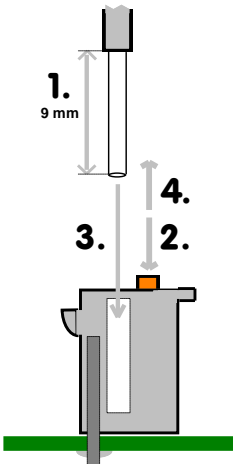

Inserting a core into a self-clamping type terminal:

- [1.] remove core insulation over a section of 9mm (as per Figure);
- [2.] for multi-stranded core cables (rope) – twist the strands on the end slightly;
- [3.] press the orange lock button, push the stripped wire into the opening of the terminal up to the stop, [4.] and release the button;
- [3.] for single-stranded wire, use pliers or manually push the stripped core end into the round opening of the terminal up to the stop.

A properly inserted cable cannot be dislodged from the terminal.

The conductor can be released and removed by pressing the orange button. [2.].

4.2.3. The cable ends should be prepared in such a way that, when inserted into the terminal chamber, the conductors attached to the terminals would not have to be curled up inside the module and that the gland seal would enclose the outer insulation of the cable.



The cable should be clamped firmly enough in the gland so that it does not move within the MD when attempting to pull it out by hand (and does not transmit mechanical forces to the connection terminals). This will ensure proper sealing.

4.3. The module is delivered with the circuit for Detector No 1 enabled by default. When installing additional DEX detectors, activate their power circuits using the W1 'WYŁĄCZ.' [OFF] micro-switches on the terminal board (with the number corresponding to the detector being activated), by switching them to the 'ON' position (the [ZASILANIE] (power) light for the corresponding detector will light up).

4.4. Connect external devices, such as automation control systems, an external siren S-3x, a warning light LD-2 (with cables for the signalling devices using 2x0.5 mm² cores), etc. If visual and sound signalling devices are located in the same place, it is recommended to use an integrated visual-sound signalling device,



such as the SL-32 or SL-21. These devices have separate functions for the siren and the light, and can be connected to the MD using a three-core C3 cable (recommended configuration: 2x2x0.5). Mains voltage from different phases or low-voltage circuits can be connected to the A1 and A2 contact outputs. Only low-voltage circuits (maximum 30VAC or 24 VDC) can be connected to the FAILURE (AWARIA) contact output.

4.4.1. If it is necessary to connect more cables (after all factory-provided cable glands in the module have been used), additional glands (of a diameter suitable for the cables used) must be installed on the removable cover of the terminal chamber. Appropriate glands (IP54 or better) to maintain the module's degree of sealing must be used. Do not puncture the walls or the bottom of the module! It is prohibited to insert cables into the MD directly through drilled holes (without cable glands) or through the gasket of the terminal chamber cover.



4.5. For MD-2(4), connect the 'B' mains power cable of 230 VAC. The module is equipped with an internal single-pole power switch, but a disconnecting switch for the 230 VAC power circuit (disconnecting both supply wires, e.g. SW-20 from the GAZEX range) must be included in the power circuit to the MD. The MD does not require earthing and does not have a protective terminal. However, it is essential to maintain the correct wiring order for the 230 VAC connector: the phase wire to terminal 'L' [01], and the neutral wire to 'N' [02]. The reliability of the power supply and the absence of interference are critical for the proper operation of the system. Therefore, cable 'B' should be connected through a dedicated fuse on the distribution board. Significant voltage surges in the 230 VAC power circuit may cause damage to the internal main power fuse (*repairable by the Manufacturer or an Authorised Service Centre*) or lead to malfunctions in the MD's operation. The 230 VAC power network should be protected against surges.

For MD-...A..., connect the 'E' power cable (12 VDC or 24 VDC) from the PS-... power supply (with a connected battery) or another power source that complies with the PN-EN 50270:2007 standard for surge immunity test (according to PN-EN 61000-4-5:2006, criterion B).

Ensure correct polarity (the module is protected against reverse polarity).

'E' cable core cross-section	Length of the 'E' cable
1.5 mm ²	≤ 12 m
2.5 mm ²	≤ 20 m

PLEASE NOTE: When selecting all connecting cables, it is also necessary to take into account the requirements for the appropriate class of reaction to fire, according to Regulation (EU) No 305/2011 of the European Parliament and of the Council of 9 March 2011 (CPR), depending on the installation point in the building. Detailed regulations in this regard can be found in N SEP-E-007:2017-09 or in relevant legislation as it is published from time to time.



4.5.1. Turn the module power supply on. The presence of voltage and correct operation of the circuits are indicated by green lights: **[ZASILANIE]** (power) for the activated detectors and a flashing green **[ZASILANIE MODUŁU]** (module power) light (flashing for approx. 1 min during the warm-up). The end of the warm-up is signalled by the **[MODULE POWER]** light staying steadily on. Flashing of the detector's **[ZASILANIE]** (power) light indicates an overload of the '+' power output for that detector.

4.5.2. NOTE: During installation, an accidental short circuit in the detector's power wires, an overload in the power line, or incorrect polarity of the wires in 'A' cable will cause the automatic disconnection of the detector's power supply by an electronic fuse. This results in the detector's green **[ZASILANIE]** (power) light flashing and the generation of an A2 alarm status, along with intermittent internal siren tones. After removing the short circuit or overload, the internal fuse will resume the power supply only after turning off the module for approx. 5 s and then turning it back on.

4.5.3. Overloading or short-circuiting one of the voltage outputs **[12V ALARM OUTPUTS]** in an **A1** or **A2** status will trigger the automatic operation of a resettable fuse. After the overload or short circuit is removed, the internal fuse will automatically restore normal operation within a few seconds.

4.6. The warm-up (during which outputs are blocked) lasts approx. 1 min. After that, the detectors will resume normal operation, and none of the alarm lights should be on or flashing. The module will then enter **NORMAL** operation mode, indicating that the **System** components have been correctly installed.

4.6.1. When connecting detectors equipped with a smart sensor module MS (*with the letter 'N' at the end of the symbol on the yellow, rectangular calibration label*), upon powering on the detector, an automatic, one-time start-up sequence occurs: a 'high' status only on output '2' for a few seconds (during processor start-up) → generation of a normal status on the outputs (a 'low' status on both) for approximately 4 seconds → a pulsing signal only on output '1' for approximately 4 seconds → a pulsing signal only on output '2' for approximately 4 seconds → pulsing signals on both outputs for approximately 4 seconds → returning to the normal status on both outputs. The signals can be monitored with a voltmeter at the detector terminals or observed on the MD alarm module. Under normal conditions, the above start-up sequence is 'unnoticed' by the MD. To observe it, preheat the MD module without powering on the detectors (by turning off all detectors

using the function switch). Then, power on the individual detectors one by one. The observed lights on the front panel or letters on the display can confirm the correct wiring order.



The start-up sequence is presented for illustrative purposes. The start-up sequence described above may vary depending on the type/model of the MS sensor module installed in the detector. The sequence may have a different timing or may be interrupted if errors in the sensor or detector malfunctions are detected.

4.7. The final step in verifying the **System's** operation is generating all alarm statuses for all connected detectors.

4.8. ASSUMPTIONS:

- The **MD** module is in Normal(0) (after the sensor warm-up), with the **[ZASILANIE]** (power) lights of the detectors and **[ZASILANIE MODUŁU]** (module power) light on.
- The **DEX** detectors are not generating alarm signals (the gas concentration below the calibration thresholds):

4.8.1. One by one generate alarm statuses for each detector using test gas, following the recommendations in the detector's user manual. At this point (or with a delay of a few seconds), the corresponding **[ALARM2]** and/or **[ALARM1]** input status light for the tested detector should illuminate, and an intermittent tone from the internal siren should be heard. The internal siren can be silenced by setting the W2 'CISZA' [SILENCE] function switch to the 'ON' position.

4.8.2. If the A1 or A2 alarm signal from the DEX detector lasts for more than approximately 20 s, an alarm signal will be generated on the A1 and A2 control outputs, and the corresponding red output status light will illuminate.

4.8.3. After removing the test gas, as the gas concentration in the detector chamber decreases, the **[ALARM2]** input and output status lights will begin to flash (from steady illumination), followed by the **[ALARM1]** lights. Once all the lights are flashing, reset the alarm memory by briefly pressing the **[KASOWANIE PAMIĘCI]** (memory reset) button. All **[ALARM1]** and **[ALARM2]** lights should extinguish, and the module should return to Normal. The alarm memory can be disabled by setting the W2 'BEZ.PAM.' [NO MEMORY] function switch to the 'ON' position. The disappearance of the alarm signal will automatically extinguish the corresponding status lights.

4.8.4. The output control procedure can be simplified by pressing and holding the **[TEST]** button on the module's terminal board for several seconds. Immediately after pressing this button, only two Output Status lights should illuminate, and the appropriate control signals should appear on both outputs. After releasing the button, both Output Status lights will begin to flash (alarm memory), and the output signals will disappear. Briefly pressing the **[KASOWANIE PAMIĘCI]** (memory reset) button on the module's front panel will turn off both lights and return the module to normal operation.

4.8.5. During subsequent test procedures, if required by the system user, the operation of the alarm outputs can be blocked by setting the W2 'SERWIS' (service) function switch to the 'ON' position. After completing the detector testing, this switch should be returned to its normal 'OFF' position—down, closer to the terminal strip.

The results of the control/power-up should be recorded in the attached Periodic Inspection Record.

Following a positive test result, the **Two-Threshold Gas Detection System** can be considered operational and functional.

4.8.6. Screw the terminal chamber cover of the Module.



- Tighten the cable glands firmly (firmly enough so that they do not transfer mechanical loads when attempting to pull out the cable).
- Seal any unused cable glands (using the factory-supplied red plugs or, e.g., by clamping short pieces of cable in them).
- Securely close the transparent module cover.
- It is recommended to seal the module covers (to limit access to the MD by unauthorised persons).

PROBLEMS?

Before contacting the MD Manufacturer, check and compare the observed effects with those described below.

4.9. TABLE of exceptional statuses of the module when the power is on:

EFFECT	WHY	WHAT TO DO
[Zasilanie] (power) lights of the detectors are on, [Zasilanie modulu] (module power) light is flashing, no siren.	Detector warm-up is ongoing (all detector inputs are blocked), alarm inputs are active.	Wait approx. 1 min.
[ALARM2] and/or [ALARM1] Input Status lights of the detector are continuously on for several seconds, then start flashing.	Prolonged storage of DEX detectors or low ambient temperature caused the warm-up to last longer than the expected 1 min (applies to detectors with low calibration levels).	Briefly press the [KASOWANIE PAMIĘCI] (memory reset) button when the lights are flashing (none should be continuously on!). This should return the module to Normal(0).
[ALARM1] or [ALARM2] Input Status lights of the detector are continuously all the time.	Incorrect power polarity, damaged 'A' connection cable, or incorrect order of signal wires	Correct the polarity and cores sequence or replace the 'A' connection cable.
Only the [ALARM2] Input Status light of the detector is flashing, pressing the [KASOWANIE PAMIĘCI] (memory reset) button turns off the light, but only for a few seconds.	The detector (with a smart sensor) signals that the recommended calibration period has been exceeded; full functionality of the detector and system is retained.	Calibrate the detector sensor = disassemble the sensor module in the detector; send it to the Manufacturer or an Authorised Service Centre for calibration/replacement.
[ALARM2] and [ALARM1] Input Status lights of the detector are flashing, pressing the [KASOWANIE PAMIĘCI] (memory reset) button turns off the lights, but only for a few seconds.	The detector (only with a smart sensor) is signalling a permanent sensor failure.	Replace the detector sensor module with a new one.
[ALARM1] and [ALARM2] Output Status lights and/or [ALARM1] and [ALARM2] Input Status lights of the detector are continuously on, intermittent internal siren tone, flashing green [ZASILANIE] (power) light of the detector, [AWARIA SYSTEMU] (system failure) light is on.	Overload of more than 200 mA or short circuit in the detector power circuit.	Remove the cause of the short circuit or overload; turn off the MD power for 5 s.
At A2 or A1 status, the signalling device connected to the 12V ALARM OUTPUT is not working.	Short circuit in the connection cable or damaged signalling device, resettable fuses have tripped.	Turn off the MD power supply. Remove the short in the cable or repair the signalling device. Turn the power back on; use the 'TEST' button to check the signalling devices.
Power lights are on; [ALARM2] and/or [ALARM1] Output Status lights are on, Input Status lights are off; intermittent internal siren tone; alarm signalling is activated.	Voltage connected to the 12V Alarm Inputs on terminals A2 and/or A1 (cascading connection).	Alarm signal from external devices (native detectors in a normal status); Alarm Inputs operate without delay!
All lights are off.	No power or main power fuse damaged.	Turn on the power or replace the fuse (with an identical slow-blow fuse); make the replacement with the power disconnected.

If any effects other than those listed above are observed, contact the Authorised Service Centre or the Manufacturer.

5. MAINTENANCE / OPERATION

MD modules are electronic devices without moving parts. They are built using semiconductor components with a long service life. Therefore, their maintenance is a periodic inspection of the system:

5.1. Periodic Inspection of the System:

- ◆ Clean the MD covers from dust.
- ◆ Check the sealing of the transparent cover and cable glands.
- ◆ Notify all System users about the planned inspection.
- ◆ **Test the System according to section 4.8** of this User Manual.

*The recommended frequency of the MD periodic inspection of at least **every 3 months** is sufficient for testing the electrical and measuring properties of the System (see NOTE in section 5.2).*

- ◆ The Periodic System Inspection should also be conducted EVERY TIME after the occurrence of particular conditions in the system operation, such as:
 - occurrence of temporary extreme conditions, e.g. high gas concentration, high or very low temperature, high periodic dustiness or increase in humidity,
 - high concentrations of gases which were not anticipated in the monitored zone;
 - long-term operation with the alarm status activated,
 - after a power outage of more than approx. 3 days,
 - after voltage surges or strong disturbances in the electrical installation;
 - after renovation or installation work that may affect the operation of the system or its configuration, etc.



5.1.1 During extended operation of the module, the MD may indicate the expiry of the recommended calibration period for individual detectors—this is only visually signalled in the MD (*no reaction on the outputs, while maintaining full alarm capability*). The A2 light of the detector (indicating the expiry of the recommended calibration period) flashes slowly and cannot be reset if the MD is operating in alarm memory mode (BEZ PAM. [NO MEMORY] switch = OFF). In non-alarm memory mode (BEZ PAM. [no memory] switch = ON), the A2 light illuminates for approx. 2 s, repeating every 10 s.

5.2. NOTE:

THE FREQUENCY OF PERIODIC INSPECTIONS of the gas detection system with MD... modules

should be determined by the operating conditions, the type of detectors used, and the importance of the system/facility in the opinion of the User:

1) *It is recommended to conduct a PERIODIC INSPECTION OF THE SYSTEM after every replacement of a sensor module or calibration of any detector in the system (the frequency depends on the calibration period recommended in the technical parameters of the respective detector models).*

2) *Additionally:*

A. **Recommended** frequency of periodic SYSTEM inspections **every 3 months:**

- *for systems with detectors operating in heavily dusty, humid environments, where gas background is frequently present, and*
- *for extensive systems containing a significant number of detectors.*

B. **Normal** frequency of periodic SYSTEM inspections **every 6 months:**

- *for systems with detectors operating in generally stable conditions, without exposure to a constant gas background, and*
- *for systems controlling gas valves.*

C. **Reduced** frequency of periodic SYSTEM inspections **every 12 months:**

- *for systems with detectors operating in normally clean atmospheres and stable conditions, and*
- *for systems containing a small number of detectors/devices.*

A Periodic System Inspection should also be conducted EVERY TIME after the occurrence of particular conditions in the detection system operation, such as:

- periodic extreme operating conditions for detectors, e.g., high gas concentrations (*over 50% LEL or more than 75% of the temporarily permissible concentration range or measurement range*), extremely high or very low temperatures (*close to the recommended operating temperature limits*), high periodic dust levels, or sustained humidity increase (*at the condensation threshold*);
- presence of high concentrations of gases other than the calibration gas, which were not anticipated in the monitored zone;
- extended operation in the A2 alarm status;
- after a power outage of more than approx. 3 days (*excluding DG-nKL/N*);
- after voltage surges or strong disturbances in the electrical installation;
- after maintenance or installation work that could affect the system's operation or configuration (*e.g., painting; floor maintenance; changes in the number, placement, or power supply of system devices, etc.*).



PLEASE NOTE: The above-mentioned frequency of System inspections can be considered to be in line with good engineering practice, based on over 30 years of experience of the Manufacturer. However, it should be emphasised that in the specific conditions of a given Customer, this frequency **may be subject to modification**, based on the principle that the more important the system is (for the Customer/User), i.e., the more the Customer cares about efficient, failure-free operation of the facility where the system is used, the more frequently the system should be inspected. When expecting to increase the level of operational safety of their facility, the Customer should inspect the detection system more frequently, e.g. every 4 weeks or prior to each important event/measurement. On the other hand, where the role of the detection system is considered to be less important or based on the Customer's own assessment of the reliability of the facility's components, the Customer/User may decide to extend the inspection period e.g. to 6 or 12 months.

THE SYSTEM INSPECTION INTERVAL MUST NOT EXCEED 12 MONTHS!



ATTENTION – IMPORTANT INFORMATION: Pursuant to Regulation of the Minister of Internal Affairs and Administration of 7 June 2010 on fire protection of buildings, other constructions, and areas (*Dz.U. [Journal of Laws] of 2010 No 109, item 719*), a system for detecting hazardous concentrations of explosive gases (with automatic gas shut-off or another function preventing explosions) should be regarded as a 'fire protection device' (*Chapter 1, par. 2.1., point 9*). The Regulation requires that: operational tests be carried out (during commissioning) to confirm correct operation, and that technical inspections and maintenance be carried out at the intervals and in accordance with the recommendations of the manufacturer's user manual for the 'equipment,'

however, ***at least once a year.*** (*par. 3, points 1–3.*)

Owners, managers, or users of a facility are required to maintain 'fire protection devices' in full technical and functional working order (*Chapter 2, par. 4.2, point 1*).



5.2. During operation, the use of mobile phones, radios, or other sources of strong electromagnetic fields in the immediate vicinity of the MD should be avoided as their use may interfere with the operation of the MD and cause false alarms.

ATTENTION ! IMPORTANT !!

5.3. All of the following:

- results of each system inspection according to section 4.8. of this Manual,
- situations where an A2 alarm state was generated, along with the actions taken by the staff,
- power outages of the module lasting longer than 3 months,
- any observed unusual behaviour of the system

MUST be recorded in the attached Periodic Inspection Record under **penalty of loss of warranty** for the system components.

5.4. Long-term storage of the MD module should be carried out in dry rooms, at a temperature between -10°C and +40°C, in the factory packaging or at least in a polyethylene bag. After 3 years from the date of manufacture, the unit inspection according to the procedure in section 4.8.5. is recommended.

5.5. Pursuant to the Act of 11 September 2015 on Waste Electrical and Electronic Equipment, a used module may not be disposed of together with other household waste. It should be transferred to a specialised waste collection point. This is why it was marked with a special symbol:

Proper waste disposal protects against the adverse effects on human health and the environment.

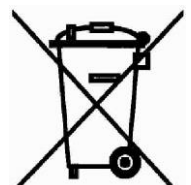

PLEASE NOTE:

Due to the continuous improvement of our products and our desire to provide the most complete and detailed information possible on them and to provide the know-how necessary for the correct, long-term operation of our products based on our customers' experiences to date, GAZEX reserves the right to make minor changes to the technical specifications of the products supplied, while such changes and not included in this User Manual, and to modify the latter. For this reason, please verify and confirm with the Manufacturer that your User Manual is up to date (please state the exact type and series of the device in use, as well as the manual edition number – from the footer of the document).

6. WARRANTY TERMS AND CONDITIONS

The device is covered by the Gazex Standard Warranty 3 years plus (SGG3Y+) in Poland according to the terms and conditions of SGG3Y+ available at www.gazex.pl. Selected extracts from the SGG3Y+ terms and conditions:

- ...
1. GAZEX guarantees the efficient operation of devices of its own manufacture for the period up to the end of the year in which the device was manufactured and for another three years.
 - 1.1. The year of manufacture is determined on the basis of the device's nameplate (*warranty cards are not issued!*).
 - 1.2. If the nameplate is illegible – the year of manufacture will be determined on the basis of the serial number or the code labels on the components (*if any*) together with the records in the GAZEX electronic manufacturing surveillance system. Such verification is subject to a charge. The fee is PLN 50.00 net for each started verification of a batch of up to 10 devices.
 - 1.3. Non-identifiable devices, i.e. with a damaged/illegible nameplate or no nameplate at all and with the GAZEX logo removed/covered permanently, shall not be subject to the warranty.
 - 1.4. The SGG3Y+ warranty covers all devices manufactured by GAZEX after 1 January 2021 which display the year of manufacture '2021' or later on the nameplate.

- ...
4. The warranty does not cover damage caused by:
 - a) mechanical shock, vibration and effects, thermal effects and chemical effects;
 - b) damages resulting from improper storage, faulty installation or improper operating conditions contrary to the device's User Manual;
 - c) failure to carry out periodic maintenance or by other negligence;
 - d) deliberate action by the user, third parties or persons not authorised to carry out repairs;
 - e) lightning, power line surges, or electrostatic charges;
 - f) force majeure or other events beyond the Manufacturer's control.

Consumables including, but not limited to, fuses, batteries, built-in batteries, gas sensors (which are covered by the GAZEX OGG+ Limited Warranty), porous sintered components are not covered by the warranty.

- ...
6. The warranty rights cease to apply in the following cases:
 - a) damage to the factory seals, service seals or identification marks on the device/components;
 - b) interference with the device's internal systems or making any other changes to the device or control software or when the device is operated with non-original components not supplied by GAZEX;
 - c) failure to carry out periodic maintenance activities, confirmed by systematic entries in the Periodic Inspection Record (enclosed with the device or devices cooperating with it) and indicated as necessary in the device's User Manual.

...

The full terms and conditions of SGG3Y+ are available at www.gazex.pl.

FAILURE TO COMPLY with all the terms and conditions of installation and operation of the detector as described in this Manual (which shall include keeping the Periodic Inspection Record) will result in the loss of warranty rights.

An extended version of the Periodic Inspection Record is available in .pdf format at: www.gazex.pl.

PLEASE NOTE:
Any complaints require that a warranty repair request or post-warranty repair request is registered on: <https://www.gazex.com/pl/serwis>

There is a possibility to extend the warranty to 5 years – Gazex Extended Warranty 5 year plus (RGG5Y+), according to the terms and conditions of RGG5Y+ available at www.gazex.pl.